

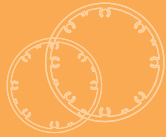

We do it your **Wayfinding**



## System Components



w w w . v i s t a s y s t e m . u s

We do it your wayfinding



Description

Sizes

Wait!  
 Before you calculate your project, consider having us do it for you. Our Staff is equipped with special software that produces quotes within minutes! Why not save your valuable time and eliminate costly mistakes?

Standard finishes are silver and black anodize.

For custom paint or anodize - please call for a quote.

Extrusion sizes V300 to V1200 are constructed from multiple extrusions and are supplied un-assembled as a kit.

Standard length is:  
 2130mm/4260mm (7'/14').  
 Custom made widths are available, please call for quote and lead time of the frame and accessories.  
 Gold anodize extrusions are shelf items but are not always available in large quantity.

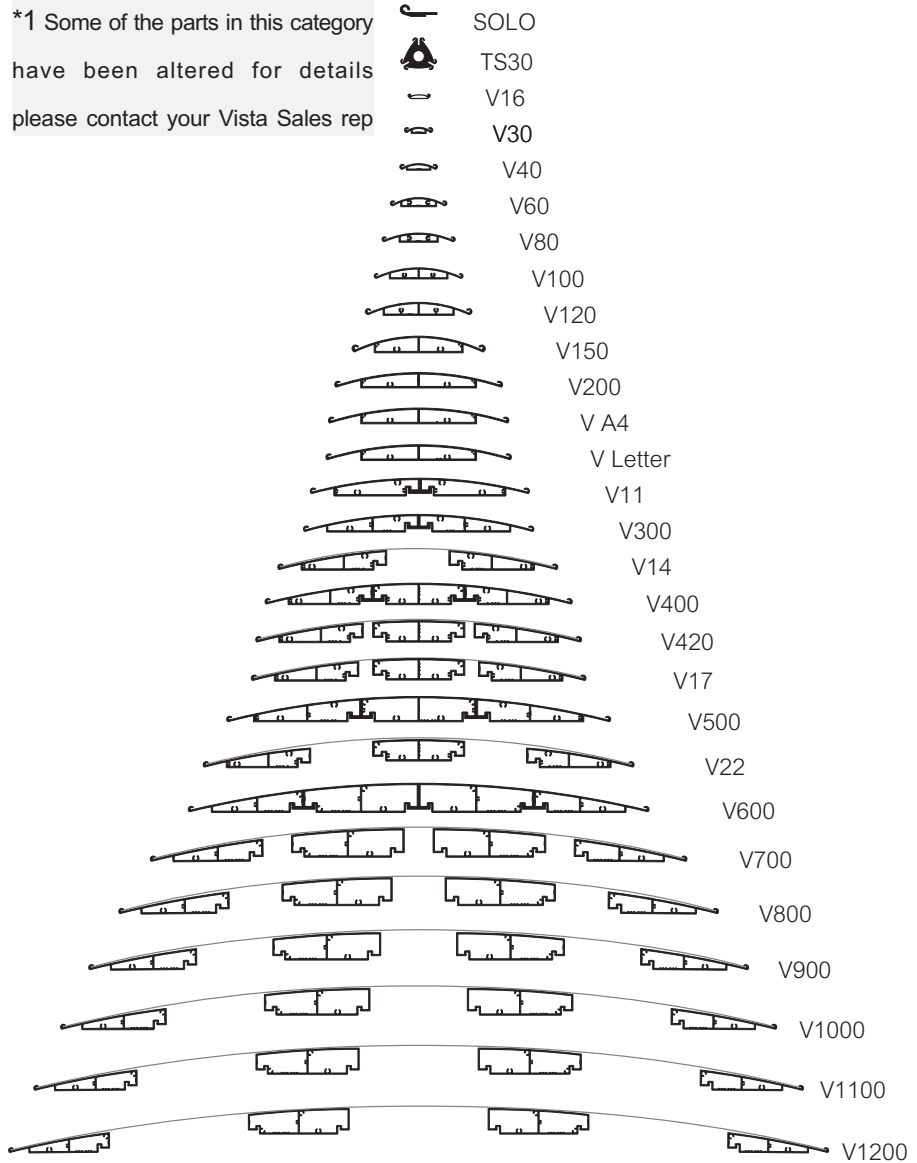

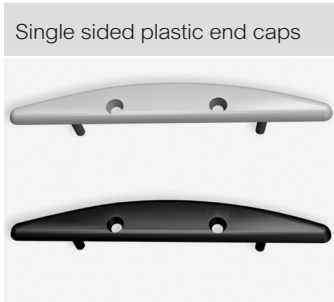

Part number	Frame width	Insert size	Part number	Frame width	Insert size
V16	18mm /0.7"	15.7mm /0.62"	V420 (A3 Landscape)	424.2mm/16.7"	420mm/ 16.54"
V30	30mm/ 1.18"	26mm/ 1.02"	V17 (17")	435.8mm/17.15"	432mm/ 17"
V40	40mm/ 1.57"	36mm/ 1.41"	V500	500mm/ 19.68"	500mm/ 19.68"
V60	60mm/ 2.36"	58mm/ 2.28"	V22 (22")	561mm/ 22.08"	559mm/ 22"
V80	80mm/ 3.14"	78mm/ 3.07"	V600	600mm/ 23.62"	600mm/ 23.62"
V100	100mm/ 3.93"	97.5mm/ 3.838"	V700	713mm/ 28.08"	709mm/ 27.91"
V120	120mm/ 4.72"	118mm/ 4.645"	V800	815.7mm/32.11"	811mm/ 31.93"
V150 (A5)	150mm/ 5.90"	148mm/ 5.826"	V900	915.6mm/36.05"	912mm/ 35.91"
V200	200mm/ 7.87"	198mm/ 7.8"	V1000	1016mm/ 40"	1014mm/ 39.92"
VA4 (A4)	215mm/ 8.46"	210mm/ 8.27"	V1100	1117mm/ 44"	1115.5mm/43.922"
VLetter (Letter)	221mm/ 8.70"	215.9mm/8.5"	V1200	1218mm/ 48"	1217mm/ 47.91"
V11 (11")	282.5mm/11.12"	279mm/ 11"	TS30	31mm/ 1.22"	27mm/ 1.063"
V300 (A3 Portrait)	300mm/ 11.81"	297mm/ 11.69"	V-SOLO	-	-
V14 (14")	360mm/ 14.17"	355.5mm/14"			
V400	400mm/ 15.74"	400mm/ 15.75"			

Plastic end caps	Part number	Metal end caps	Part number
<p>Standard finishes are grey and black.</p> <p>PEC80 and up are provided with matching screws. Screws can be added to PEC60 for an additional cost. Custom colours are available, please call for cost and lead time.</p>	PECTS30	<p>Metal end caps are available in brushed aluminium, gold and black anodized aluminum and are provided with matching screws.</p>	MEC60
	PEC30		MEC80
	PEC40		MEC100
	PEC60		MEC120
	PEC80		MEC150
	PEC100		MEC200
	PEC120		MECA4
	PEC150		MECLetter
	PEC200		MEC11
	PECA4		MEC300
	PECLetter		MEC14
	PEC300		MEC400



Clear lenses	Part number	Thickness	Material
<p>* Available glossy on one side and non-glare on the other side, for indoor and outdoor use.</p> <p>The clear lenses are an excellent low cost material that can be used as a substrate for digitally printed vinyl.</p>	* CC16	0.25mm (0.01")	Polycarbonate
	* CCTS30	0.25mm (0.01")	Polycarbonate
	* CC30	0.25mm (0.01")	Polycarbonate
	* CC40	0.25mm (0.01")	Polycarbonate
	** CC60	0.5mm (0.02")	Polycarbonate
	** CC80	0.5mm (0.02")	Polycarbonate
	** CC100	0.5mm (0.02")	Polycarbonate
	** CC120	1mm (0.04")	Polycarbonate
	** CC150	1mm (0.04")	Polycarbonate
	** CC200	1 mm(0.04")	Polycarbonate
	** CCA4	1 mm(0.04")	Polycarbonate
	** CCLetter	1 mm(0.04")	Polycarbonate
	** CC11	1mm (0.04")	Polycarbonate
	** CC300	1.5mm (0.06")	Polycarbonate
	** CC14	2mm(0.08")	Polycarbonate
	** CC400	1mm (0.04")	Polycarbonate
	** CC420	2mm(0.08")	Polycarbonate
	** CC17	2mm (0.08")	Polycarbonate
	** CC500	1mm(0.04")	Polycarbonate
	** CC22	1.5mm(0.06")	Polycarbonate
** CC600	1 mm(0.04")	Polycarbonate	
** CC700	3 mm(0.12")	Polycarbonate	
** CC800	3 mm(0.12")	Polycarbonate	
** CC900	3 mm(0.12")	Polycarbonate	
** CC1000	3 mm(0.12")	Polycarbonate	
** CC1100	3 mm(0.12")	Polycarbonate	
** CC1200	3 mm(0.12")	Polycarbonate	

Accessories	P/N	Description
	VKR	Suction cup, for removing the lenses.
	VS 13600	Divider strip, 61cm/24" long, for making sections in directory frames. Are available in silver, black, blue, yellow and red.
	TSD	2 Step Drill, for mounting holes.

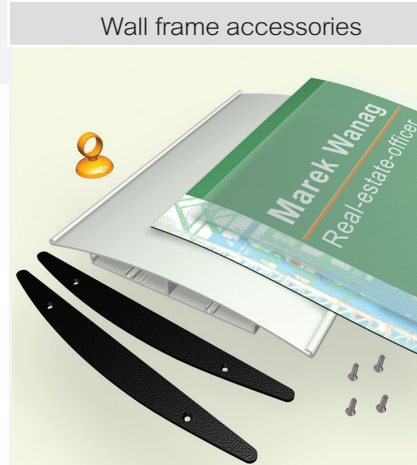



### Aluminium end caps

Double sided aluminium end caps, slim design, are available in brushed aluminium, gold and black finishes and are provided with matching screws.

Slim design	Part number
	DSECA4A DSECLetterA DSEC11A DSEC300A DSEC400A DSEC420A DSEC500A DSEC600A

\*1

### Slim design



### Wide design



### Aluminium end caps

Double sided aluminium end caps, wide design, are available in brushed aluminium, gold and black finishes and are provided with matching screws.

Wide design	Part number
	DSEC200S DSECA4S DSECLetterS DSEC11S DSEC300S DSEC400S DSEC420S DSEC500S DSEC600S DSEC700S DSEC800S DSEC900S DSEC1000S DSEC1100S DSEC1200S

\*1

\*1 Some of the parts in this category have been altered for details please contact your Vista Sales rep

### Steel bases

All bases are supplied painted black.

Slim design - Floor mounted	Part number
	BA4A BLetterA B11A B300A B400A B420A B500A B600A



Slim design - Free standing	Part number
	BOVSA150A BOVSA200A BOVSA4A BOVSALetterA BOVSA11A BOVSA300A BOVSA400A BOVSA420A BOVSA500A BOVSA600A



### Steel bases

All bases are supplied painted black

Wide design - Floor mounted	Part number
	B200S BA4S BLetterS B11S B300S B400S B420S B500S B600S B700S B800S B900S B1000S B1100S B1200S

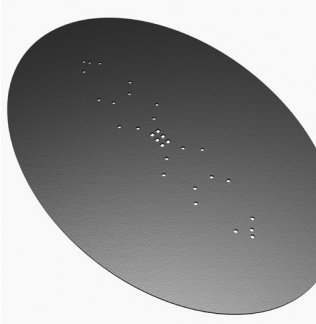

Wide design - Free standing	Part number
	BOVSA200S BOVSA4S BOVSALetterS BOVSA11S BOVSA300S BOVSA400S BOVSA420S BOVSA500S BOVSA600S BOVSA700S BOVSA800S BOVSA900S BOVSA1000S BOVSA1100S BOVSA1200S

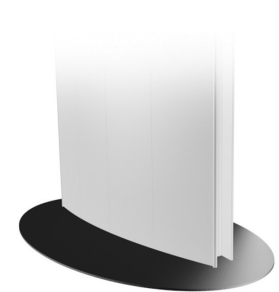

### Spacer extrusion

These profiles are an accessory for the double sided pylon - wide design.



PS30

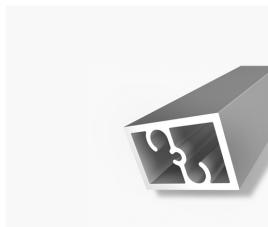

PS2030 for V200-V600

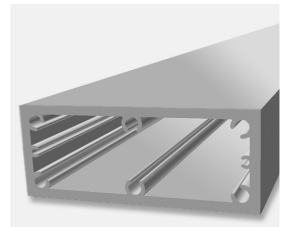

PS40100 for V700-V1200

\* Mounting screws/bolts are not provided.

Aluminium end caps

Double-sided end cap wide design, with one additional round post mounting in the centre are available in brushed aluminium, gold and black finishes and are provided with matching screws.

Double sided with additional post Part number

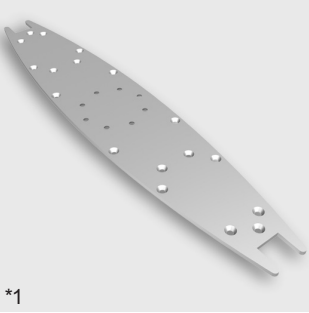

\*1

- DSEC200SP40
- DSECA4SP40
- DSECLetterSP40
- DSEC11SP40
- DSEC300SP40
- DSEC300SP60
- DSEC400SP60
- DSEC400SP80
- DSEC420SP80
- DSEC500SP60
- DSEC500SP80
- DSEC600SP60
- DSEC600SP80
- DSEC600SP100
- DSEC700SP80
- DSEC700SP100
- DSEC800SP80
- DSEC800SP100
- DSEC900SP100
- DSEC1000SP100
- DSEC1100SP100
- DSEC1200SP100

Double sided with additional post



\*1

Wide design - 1 post adjacent

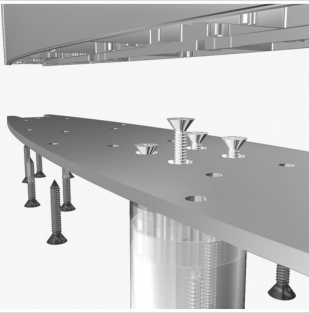

Wide design - 2 post adjacent

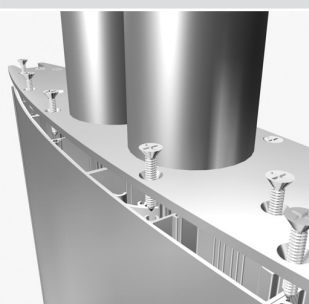

Wide design 2 post non adjacent



Aluminium end caps

Double-sided end cap wide design, with two additional round post mountings: A=Adjacent, NA=Non Adjacent.

Available in brushed aluminium, gold and black finishes and are provided with matching screws.

Wide design - 2 post attached Part number

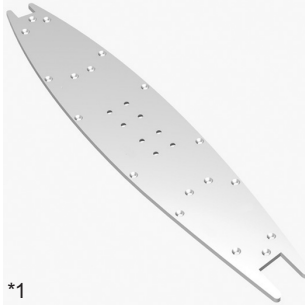

\*1

- DSEC300S-2P40-A
- DSEC400S-2P40-A
- DSEC400S-2P60-A
- DSEC500S-2P40-A
- DSEC500S-2P60-A
- DSEC600S-2P40-A
- DSEC600S-2P60-A
- DSEC700S-2P60-A
- DSEC700S-2P80-A
- DSEC800S-2P60-A
- DSEC800S-2P80-A

Wide design - 2 post separated

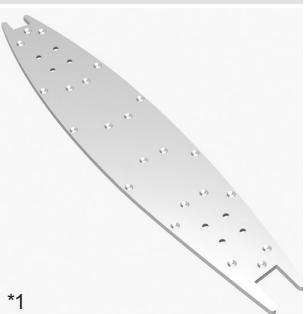

\*1

- DSEC400S-2P40-NA
- DSEC500S-2P60-NA
- DSEC600S-2P60-NA
- DSEC700S-2P60-NA
- DSEC700S-2P80-NA
- DSEC800S-2P60-NA
- DSEC800S-2P80-NA
- DSEC900S-2P60-NA
- DSEC900S-2P80-NA
- DSEC1000S-2P80-NA
- DSEC1000S-2P100-NA
- DSEC1100S-2P80-NA
- DSEC1100S-2P100-NA
- DSEC1200S-2P80-NA
- DSEC1200S-2P100-NA

\*1 Some of the parts in this category have been altered for details please contact your Vista Sales rep

Post extrusions

Standard extrusion finishes are silver & black, for custom paint or anodize please call for a quote, gold anodize extrusions are shelf items but are not always available in large quantity. Standard length is 2130mm/4260mm.

Part number



Post - Extrusions



Post connector

Connector elements for joining two post extrusions P40, P60, P80,P100

Post connectors Part number



- COP40-38
- COP60
- COP80
- COP100

Aluminum end caps

The post end caps are available in brushed aluminium, gold and black finishes and are provided with matching screws.

Part number



- CRECP40
- CRECP60
- CRECP80
- CRECP100

Steel bases

Post base circle design, floor mounted. All the bases are painted black and provided with matching screws.

Floor mounted

Part number

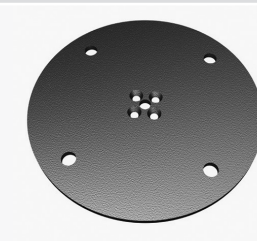

- BCR200P40
- BCR200P60
- BCR200P80
- BCR200P100
- BCR250P40
- BCR250P60
- BCR250P80
- BCR250P100
- BCR300P40
- BCR300P60
- BCR300P80
- BCR300P100

Steel bases

Free standing

Post base circle design, free standing. All the bases are painted black and provided with matching screws.

Part number

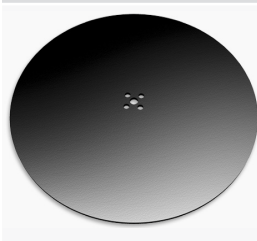

- BCRSA300P40
- BCRSA300P60
- BCRSA300P80
- BCRSA300P100
- BCRSA400P40
- BCRSA400P60
- BCRSA400P80
- BCRSA400P100
- BCRSA500P40
- BCRSA500P60
- BCRSA500P80
- BCRSA500P100
- BCRSA600P100
- BCRSA700P100

\* Mounting screws/bolts are not provided.

Post - Triangular

Aluminum end caps

Triangular end cap with one additional round post mounting in the centre.

Available in brushed aluminium, gold and black finishes and are provided with matching screws.

Triangular with additional post

Part number

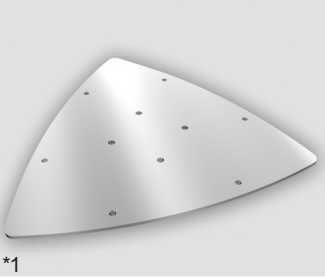

- TREC150P40
- TREC150P60
- TREC150P80
- TREC150P100
- TREC200P40
- TREC200P60
- TREC200P80
- TREC200P100
- TRECA4P40
- TRECA4P60
- TRECA4P80
- TRECA4P100
- TRECLetterP40
- TRECLetterP60
- TRECLetterP80
- TRECLetterP100
- TREC300P40
- TREC300P60
- TREC300P80
- TREC300P100
- TREC400P60
- TREC400P80
- TREC400P100
- TREC500P80
- TREC500P100
- TREC600P80
- TREC600P60
- TREC600P100
- TREC3003P40
- TREC4003P40
- TREC5003P40
- TREC6003P40
- TREC7003P40
- TREC8003P60
- TREC9003P60
- TREC10003P80

Triangular with 3 additional posts

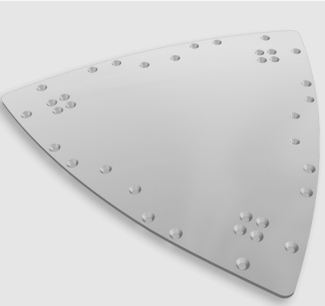

Triangular with 3 additional posts attached on the top and through the bottom



Post - Triangular

Aluminum end caps

Triangular end cap with additional round hole for post mounting.

Available in brushed aluminium, gold and black finishes and are provided with matching screws.

A round hole for post mounting

Part number

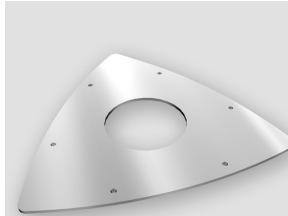

\*1

3 round holes for post mounting

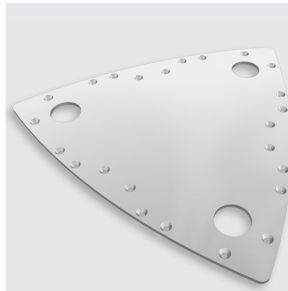

\*1

- TREC150H60
- TREC150H80
- TREC200H60
- TREC200H80
- TREC200H100
- TRECA4H60
- TRECA4H80
- TRECA4H100
- TRECLetterH60
- TRECLetterH80
- TRECLetterH100
- TREC300H60
- TREC300H80
- TREC300H100
- TREC400H60
- TREC400H80
- TREC400H100
- TREC500H80
- TREC500H100
- TREC600H80
- TREC600H100
- TREC4003HP40
- TREC5003HP40
- TREC6003HP40
- TREC7003HP40
- TREC8003HP60
- TREC9003HP60
- TREC10003HP80

Triangular Signs

Aluminum end caps

Triangular aluminium end caps.

Available in brushed aluminium, gold and black finishes and are provided with matching screws.

Triangular end cap

Part number

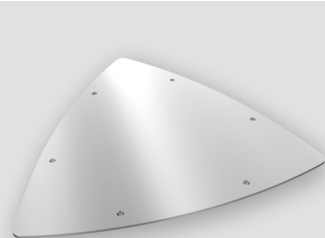

- TREC100
- TREC120
- TREC150
- TREC200
- TRECA4
- TRECLetter
- TREC11
- TREC300
- TREC400
- TREC420
- TREC500
- TREC600
- TREC700
- TREC800
- TREC900
- TREC1000

\*1

Triangular base design



Triangular end cap



Steel bases

Triangular base design

All the bases are painted black and include matching screws.

Free standing

Part number



- BTRSA150
- BTRSA200
- BTRSA44
- BTRSA11
- BTRSALetter
- BTRSA300
- BTRSA400
- BTRSA420
- BTRSA500
- BTRSA600
- BTRSA700
- BTRSA800
- BTRSA900
- BTRSA1000

Floor mounted

Part number



- BTR400
- BTR500
- BTR600
- BTR700
- BTR800
- BTR900
- BTR1000
- BTR1200

Aluminum/Steel

Deluxe/Standard

Standard finishes black powder coat.



Aluminium end caps

Simple base

Double sided end caps and bases for wall mounted brackets, slim design. End caps are available in brushed aluminum, gold and black finishes and are provided with matching screws. All bases are painted black.



Wall Brackets - Simple base

Aluminum deluxe/Steel standard

Part Number



Aluminum Deluxe	WB100D
	WB150D
	WB200D
	WB300D
Steel Standard	WB100S
	WB150S
	WB200S
	WB300S

Aluminum end caps

Part Number

Steel Wall Bases

Part Number



DSEC100A
DSEC120A
DSEC150A
DSEC200A
DSECA4A
DSECLetterA
DSEC11A



BSB100A
BSB120A
BSB150A
BSB200A
BSBA4A
BSBLetterA
BSB11A

Suspended

SUS



Accessories

Description	Part Number	Description	Part Number
Alignment Jig	AJ1	Cable Clamp	1MMC
Double-Sided connector	DC60 DC200 DC80 DC300 DC100 DC400 DC120 DC500 DC150 DC600	Stainless Steel Cable Ø1.5mm	HC100
		Cable Gripper	CG

Table stands

TS

Aluminium end caps

Kangaroo style

Aluminum base, for table stand, Kangaroo style. Available in brushed aluminum, gold and black finishes and are provided with matching screws.



Part number

KMB60
KMB80
KMB100
KMB120
KMB150
KMB200
KMBA4
KMBLetter
KMB11
KMB300

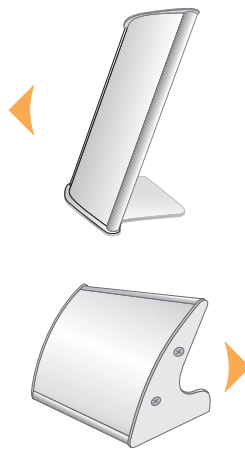

Aluminium end caps

Boomerang style

Aluminum end cap, for table stand, Boomerang style. Available in brushed aluminum, gold and black finishes and are provided with matching screws.



Part number

BMEC60
BMEC80
BMEC100
BMEC120
BMEC150
BMEC200
BMECA4
BMECLetter
BMEC11



Description

Sizes

Standard finishes are silver and black anodize.

For custom paint or anodize please call for a quote. Standard length is 4260mm or 14'. Custom sizes are available. Vista light products are pre assembled and then broken down for delivery.

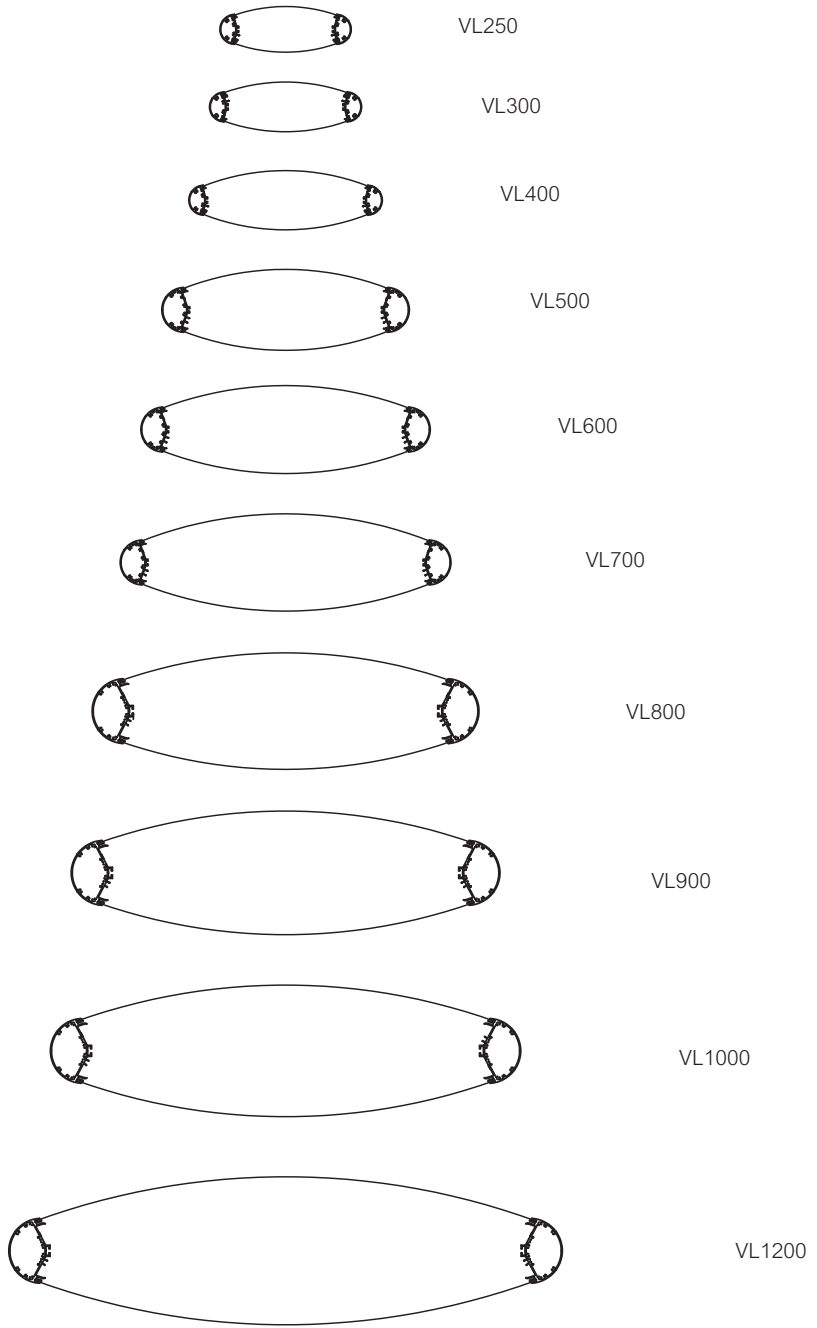
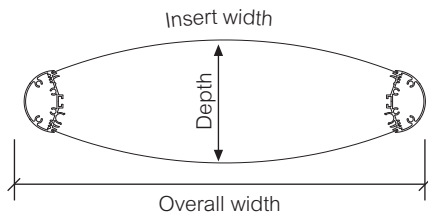
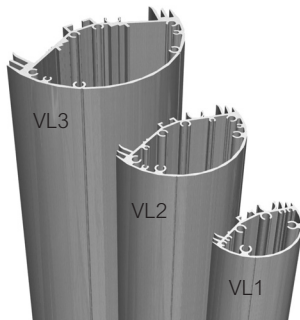

Frame number	Extrusion part number	Overall width	Depth	Insert width	CC Max. Thickness
VL250	VL1	312.5mm/12.31"	107.5mm/4.23"	254mm/10"	1.5mm/0.06"
VL300	VL1	362mm/14.26"	117mm/4.60"	305mm/12"	1.5mm/0.06"
VL400	VL1	461mm/18.14"	140mm/5.50"	406mm/16"	1.5mm/0.06"
VL500	VL2	589.5mm/23.20"	191mm/7.51"	508mm/20"	2.0mm/0.08"
VL600	VL2	689mm/27.13"	207.5mm/8.17"	609.5mm/24"	2.0mm/0.08"
VL700	VL2	788mm/31.02"	230mm/9.04"	711mm/28"	2.0mm/0.08"
VL800	VL3	921.5mm/36.28"	277.5mm/10.81"	813mm/32"	3.0mm/0.12"
VL900	VL3	1021.5mm/40.21"	291.5mm/11.47"	914mm/36"	3.0mm/0.12"
VL1000	VL3	1120.5mm/44.11"	310.5mm/12.23"	1016mm/40"	3.0mm/0.12"
VL1200	VL3	1318.5mm/51.91"	349.5mm/13.76"	1219mm/48"	3.0mm/0.12"



Aluminium end caps		Part number	Vista Light - End cap	Steel bases		Part number
Top end cap		DSECVL250 DSECVL300 DSECVL400 DSECVL500 DSECVL600 DSECVL700 DSECVL800 DSECVL900 DSECVL1000 DSECVL1200		Floor mounted base		BVL250 BVL300 BVL400 BVL500 BVL600 BVL700
Bottom end cap		DSECBVL800 DSECBVL900 DSECBVL1000 DSECBVL1200	Vista Light - Bottom end cap			BVL3
End cap for additional post		DSECVL250P60 DSECVL300P60 DSECVL400P60 DSECVL500P80 DSECVL600P100 DSECVL700P100			Free standing	
End cap for 2 post adjacent		DSECVL400-2P40-A DSECVL500-2P60-A DSECVL600-2P60-A DSECVL600-2P80-A DSECVL700-2P80-A DSECVL800-2P80-A	Vista Light - Base			BSAVL3
End cap for 2 post separated		DSECVL600-2P60-NA DSECVL700-2P80-NA DSECVL800-2P80-NA DSECVL800-2P100-NA DSECVL900-2P80-NA DSECVL900-2P100-NA DSECVL1000-2P80-NA DSECVL1000-2P100-NA DSECVL1200-2P100-NA				
Vacuum Formed end cap		VFECVL250 VFECVL300 VFECVL400 VFECVL500 VFECVL600 VFECVL700 VFECVL800 VFECVL900 VFECVL1000 VFECVL1200				
			Vista Light connector		White translucent lenses	
			Part number	Part number	Thickness	Material
			COVL250	CCVL250	1.2mm/0.048"	Polycarbonate
			COVL300	CCVL300	1.2mm/0.048"	Polycarbonate
			COVL400	CCVL400	1.2mm/0.048"	Polycarbonate
			COVL500	CCVL500	2mm/0.080"	Polycarbonate
			COVL600	CCVL600	2mm/0.080"	Polycarbonate
			COVL700	CCVL700	2mm/0.080"	Polycarbonate
			COVL800	CCVL800	3mm/0.120"	Polycarbonate
			COVL900	CCVL900	3mm/0.120"	Polycarbonate
			COVL1000	CCVL1000	3mm/0.120"	Polycarbonate
			COVL1200	CCVL1200	3mm/0.120"	Polycarbonate

Description

Sizes

Standard finishes are silver and black anodize.

For custom paint or anodize please call for a quote. Custom sizes are available. Vista light products are pre assembled and then broken down for delivery.

Sheet Metal

Part number

- SSECVL250WM
- SSECVL300WM
- SSECVL400WM
- SSECVL500WM
- SSECVL600WM
- SSECVL700WM
- SSECVL800WM
- SSECVL900WM
- SSECVL1000WM
- SSECVL1200WM

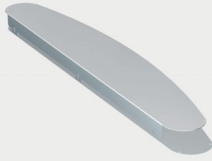

Vista Light connector

Part number

- COVL250WM
- COVL300WM
- COVL400WM
- COVL500WM
- COVL600WM
- COVL700WM
- COVL800WM
- COVL900WM
- COVL1000WM
- COVL1200WM

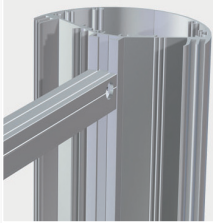

SSVL250



SSVL300



SSVL400



SSVL500



SSVL600



SSVL700

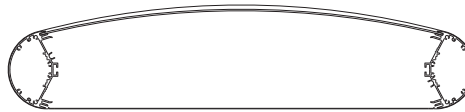

SSVL800

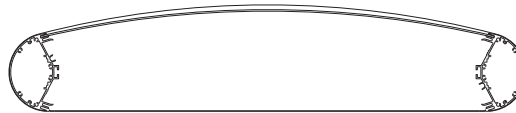

SSVL900



SSVL1000

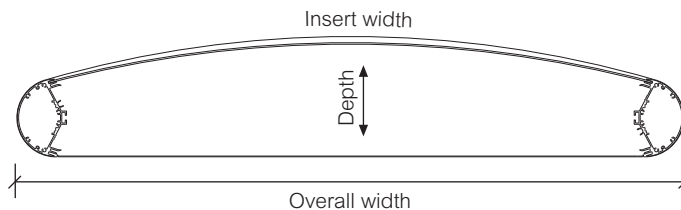

SSVL1200

Frame number	Extrusion part number	Overall width	Depth	Insert width	CC Max. Thickness
SSVL250	VL1	315mm/12.4"	97mm/3.8"	254mm/10"	1.5mm/0.06"
SSVL300	VL1	378mm/14.5"	93mm/3.65"	305mm/12"	1.5mm/0.06"
SSVL400	VL1	468mm/18.4"	99mm/3.9"	406mm/16"	1.5mm/0.06"
SSVL500	VL1	567mm/22.35"	112mm/4.40"	508mm/20"	2.0mm/0.08"
SSVL600	VL2	700mm/27.55"	147mm/5.8"	609.5mm/24"	2.0mm/0.08"
SSVL700	VL2	800mm/31.5"	154mm/6"	711mm/28"	2.0mm/0.08"
SSVL800	VL3	932mm/36.7"	207mm/8.2"	813mm/32"	3.0mm/0.12"
SSVL900	VL3	1032mm/40.6"	212mm/8.4"	914mm/36"	3.0mm/0.12"
SSVL1000	VL3	1133mm/44.6"	220mm/8.6"	1016mm/40"	3.0mm/0.12"
SSVL1200	VL3	1332mm/52.45"	240mm/9.45"	1219mm/48"	3.0mm/0.12"

Description

The Vista Light Projecting Wall Bracket is a double-sided Vista Light sign supported internally by two or more wall brackets and includes internal supports.

Standard finishes are silver and black anodize.

For custom paint or anodize please call for a quote. Custom sizes are available. Vista light products are pre assembled and then broken down for delivery.

Sizes



VL250

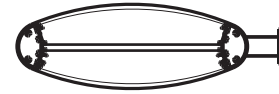

VL300

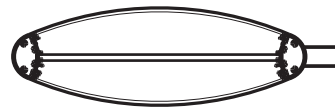

VL400

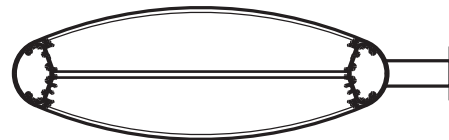

VL500

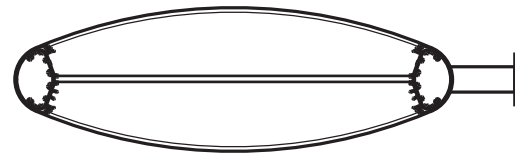

VL600

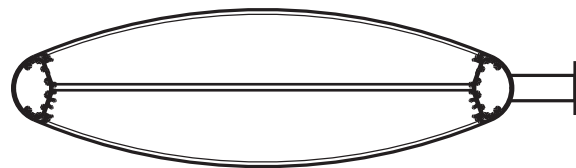

VL700

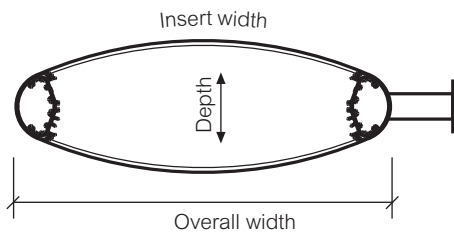

Frame number	Overall width	Depth	Insert width	CC Max. Thickness	Wall bracket element
VL250	312.5mm/12.31"	107.5mm/4.23"	254mm/10"	1.5mm/0.06"	WBVL1P30BA / WBVL1P30CA
VL300	362mm/14.26"	117mm/4.60"	305mm/12"	1.5mm/0.06"	WBVL1P30BA / WBVL1P30CA
VL400	461mm/18.14"	140mm/5.50"	406mm/16"	1.5mm/0.06"	WBVL1P30BA / WBVL1P30CA
VL500	589.5mm/23.20"	191mm/7.51"	508mm/20"	2.0mm/0.08"	WBVL2P40BA / WBVL2P40CA
VL600	689mm/27.13"	207.5mm/8.17"	609.5mm/24"	2.0mm/0.08"	WBVL2P40BA / WBVL2P40CA
VL700	788mm/31.02"	230mm/9.04"	711mm/28"	2.0mm/0.08"	WBVL2P40BA / WBVL2P40CA

\*CA=Silver anodize \*BA=Black anodize





We do it your **Wayfinding**

w w w . v i s t a s y s t e m . u s



Copyright © Vista System. All rights reserved