

2018

ADA SIGNS

CCSW SIGN SYSTEMS CATALOG



The only thing
that's changed is
the technology

Education K-12

Higher Education

Healthcare

Corporate

Government

VisiTouch®

Acciint Series®

PolTouch®

AlumSet®

Spinnaker®



2018

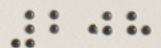

CORPUS CHRISTI STAMP WORKS, INC.

CCSW

Architectural Graphics and Sign Systems

www.ccswsignsystems.com

The VisiTouch® line is constructed of the very same plastic laminates, metals and acrylics used in educational facilities and commercial buildings. This allows professional designers to match the exact color or material of any decor. All VisiTouch® signs will have raised text and braille making them compliant to current ADA standards.

GP1- Accent series, MAP (Matthews Architectural Paint) Series, Spinnaker Series, AlumiSet and AlumiSet FX - Non ADA or Secondary text applications. Text is engraved in the face material and paint filled with a contrasting color. permanent process.

GP2- Accent Series, Spinnaker Series, AlumiSet and AlumiSet FX - ADA applications. The ADA sign background is .030 plastic laminate adhered to a clear acrylic core. Core thickness depends on the series. ADA text is laser cut out of the face laminate to expose the acrylic core. The 1/16" raised text is laser cut and then chemically welded to the acrylic core leaving 1/32" raised ADA text. This also creates a vandal resistant product. Grade 2 Braille is applied by precision drilled holes and acrylic or glass raster beads are press fitted into place. Permanent process.

GP3- MAP Series, Spinnaker Series, AlumiSet and AlumiSet FX —Non ADA or secondary information. Text is reverse applied to back of clear acrylic face. Acrylic thickness depends on Series. The sign background is reverse painted leaving text "sub-surface" and vandal proof.

GP4- Accent Series, MAP Series, Spinnaker Series, AlumiSet and AlumiSet FX — Non ADA or secondary information or changeable message applications. Vinyl text is typically applied to laminate, metal, acrylic or clear lens depending on Series.

GP5- MAP Series, AlumiSet and AlumiSet FX —ADA Compliant. Text is 1/32" laser cut Integral colored plastic typically applied to the face of the background material. Grade 2 Braille is applied by precision drilled holes and acrylic, glass or stainless raster beads are press fitted into place. Permanent Process.

GP6- Accent Series, MAP Series, AlumiSet and AlumiSet FX. This process is non ADA or secondary information used in changeable message signage. Digital printed text on clear film or cardstock is placed behind a clear lens.

GP7- MAP Series, Spinnaker Series, AlumiSet and AlumiSet FX - 1/32" Integral colored plastic text is laser cut and applied to the face of the acrylic or aluminum face creating the ADA compliant sign. Grade 2 Braille is applied by precision drilled holes and acrylic or glass or stainless steel raster beads are press fitted into place.



PT-CA-4x7
Photopolymer



AS-CM-GP2-7x7
Laminate Raised
Printed Graphic



SP-CM-GP2-5x5
Laminate with Digital Printed
Insert



AL-CM-GP2- 5.5x7
Painted Aluminum
Extrusion with Digital
Printed Inserts



AS-CA-GP2- 8x8
Standard Laminate with
Basic Text and Braille

GP8- PoliTouch Series - Photopolymer one piece construction on 1/16", 1/8", 1/4" or 3/8" Novapolymer material. Text and Grade 2 Braille is incorporated into the one piece. Text colors are applied by heat treatment and overall sign is clear coated for interior and exterior use.

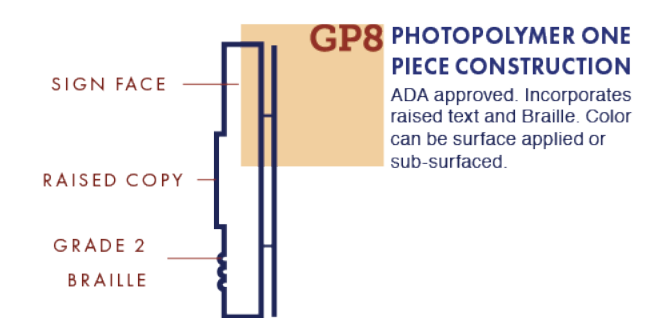
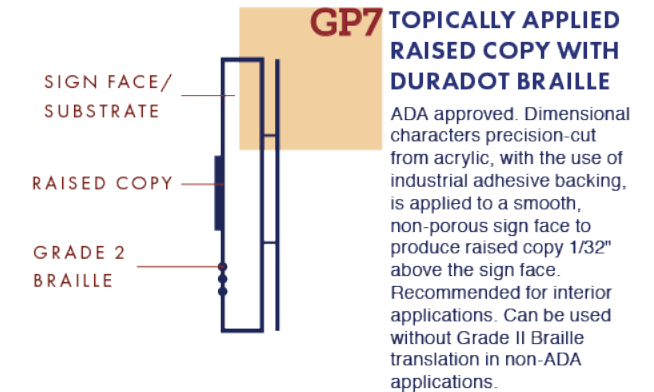
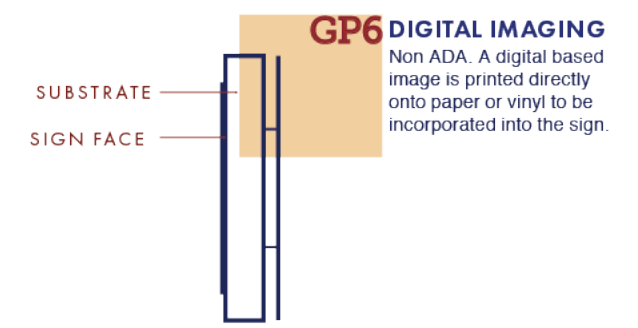
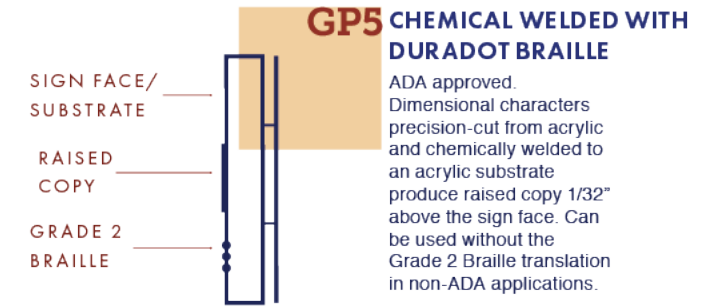
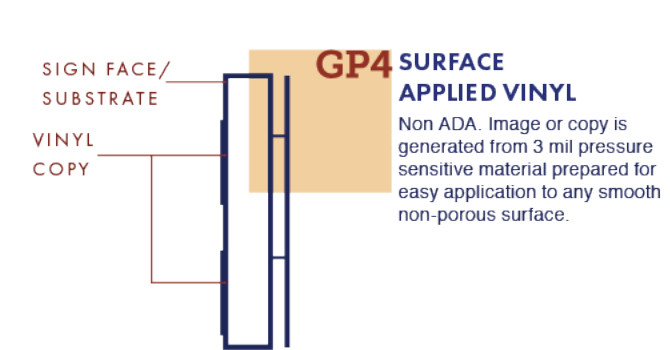
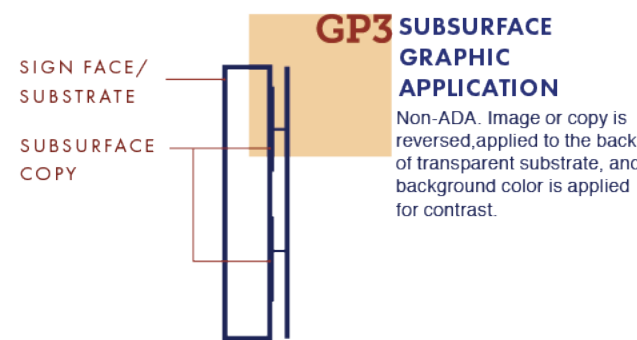
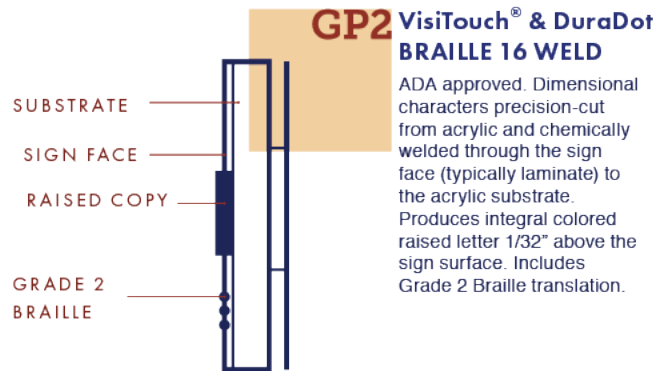
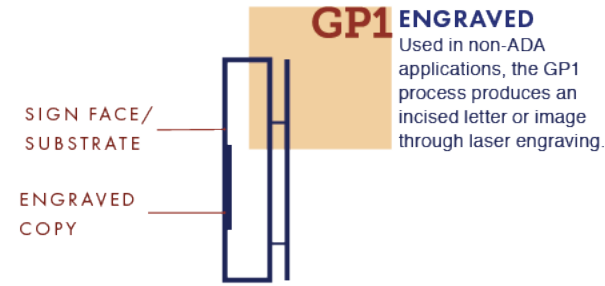

ADA 151 Coronation White	ADA 151 Waxen White	ADA 401 Pale Pebble	ADA 421 Mission Grey	ADA 361 Coffee Cream	ADA 102 Silver Shimmer	ADA 104 Heavy Metal	VisiTouch® Raised Text and Symbol (Can be used in GP2, GP5, and GP7 processes)
ADA 101 Dynasty White	ADA 726 Antler	ADA 482 Coral Sand	ADA 468 Bamboo Shoot	ADA 462 Truffle	ADA 412 Raisin	ADA 426 Falcon Wing	
ADA 541 Academy Blue	ADA 539 Nautical Blue	ADA 335 Robinhood Green	ADA 711 Valentine Red	ADA 195 Brandied Crimson	ADA 4975 Bahama Brown	ADA 501 Black	

Accent Series®

The Accent Series® is the preferred choice among architects. This sign system utilizes various plastic laminates such as Wilsonart, Nevamar, Formica and Pionite, etc. Through the use of laminates, this sign system gives the architect and designer the same durability, patterns and color range as cabinet work and doors.

- +INTEGRAL CONSTRUCTION
- +ADA COMPLIANT
- +RESISTANT TO VANDALISM
- +ECO-FRIENDLY
- +INTERIOR & EXTERIOR
- +PHOTO-LUMINESCENT
- +CHANGEABLE MESSAGE OPTION



AS-CA-GP2-8x10.5
Laminate, Customable Alum. Bars



AS-CA-GP2-6x8
Laminate, 3-Form and Alum Bars



AS-CA-GP2-8x10.5
Laminate, 3-Form and Alum Bars



AS-CA-GP2-8x8 In-laid
Laminates, engraved paint filled graphic



AS-CA-GP2-6x8
Laminates with Reveal



AS-CM-GP2-6x9
In-laid Laminates



AS-CA-GP2-6x6
Laminate, Digital Printed Raised Graphic

STANDARD SIGN TYPES

(Custom Sizes also Available)

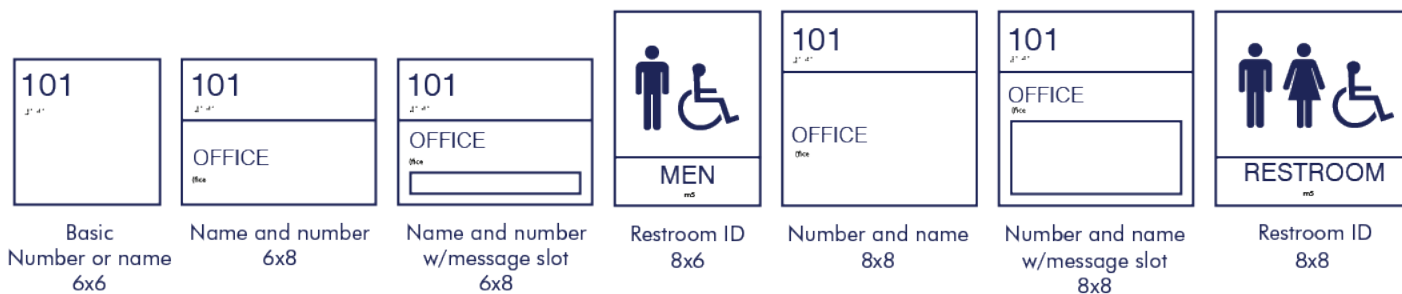

Basic Number or name 6x6
Name and number 6x8
Name and number w/message slot 6x8
Restroom ID 8x6
Number and name 8x8
Number and name w/message slot 8x8
Restroom ID 8x8

MAP Painted Series

The MAP (Matthews Acrylic Polyurethane) Painted Series gives the professional designer an exact color match to any decor. We have over 50,000 colors that we can match using our own custom paint matching system in our own professional spray booth.

The MAP Paint can be applied to the back side of the clear matte acrylic of the sign. This allows a vandal resistant finish. The MAP paint can also be applied directly to the front of the sign along with the MAP matte protective clear coat for a soft velvet finish. Other options for this process allow the designer to utilize digital printing graphics to be reverse applied to the back of the clear acrylic. The possibilities are endless.

- +ADA COMPLIANT
- +RESISTANT TO VANDALISM
- +CHANGEABLE MESSAGE OPTIONS
- +IMPERVIOUS TO WEATHER



MP-SS-CA-GP7-6x8
Painted background, Sub-Surfaced Printed Digital Graphic



MP-SS-CA-GP7-5.25x8.25
Typically Painted Background (Custom Graphics)



MP-SS-CA-GP7-7.75x11
Typically Paint, Engraved Paint Filled Graphic Custom Shape on Backer

STANDARD SIGN TYPES

(Custom Sizes also Available)

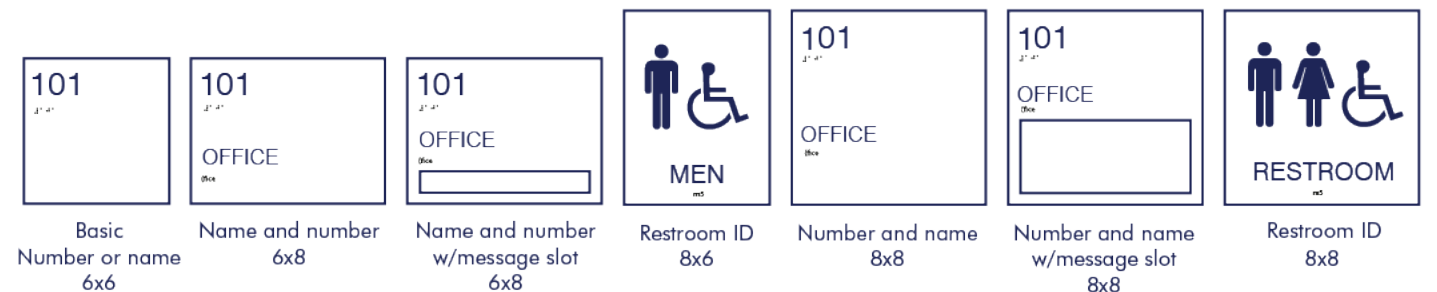

Basic Number or name 6x6
Name and number 6x8
Name and number w/message slot 6x8
Restroom ID 8x6
Number and name 8x8
Number and name w/message slot 8x8
Restroom ID 8x8



SS-CA-GP3-GP5-8x10
Sub-Surfaced Applied Metallic Film (Custom Shape)



SS-RR-GP3-GP5-9x8
Digital Printed Sub-Surfaced Background, Custom Shape



MP-SS-CA-GP7-6x7
Painted background, Custom Shape on Backer



HEAT TRANSFER FOIL FOR TEXT

PoliTouch® is a one-piece photopolymer ADA compliant sign product. Choose from several Novacryl substrates including 3 form ecoresin, patterned laminate, brushed aluminum or photo-luminescent. A clear base allows for a subsurface, digitally printed graphic or painted finish

- +ONE-PIECE CONSTRUCTION
- +ADA COMPLIANT
- +RESISTANT TO VANDALISM
- +ECO-FRIENDLY
- +SUITABLE FOR INTERIOR & EXTERIOR ENVIRONMENTS
- +PHOTO-LUMINESCENT MATERIAL AVAILABLE (GLOW IN THE DARK)
- +CHANGEABLE MESSAGE OPTION



Spinnaker® is a convex curved frame system. It is designed to handle a variety of graphic applications and substrates, including: printed paper, Printed clear film, laminates and Photopolymer. Spinnaker® is a complete system, suitable for interior or exterior environments. Frames are available in clear anodized aluminum or any Matthews Architectural Polyurethane Paint (MAP). It has a photo-luminescent option and can include Grade II Braille and tactile copy.

- +ADA COMPLIANT
- +ECO-FRIENDLY
- +SUITABLE FOR INTERIOR & EXTERIOR ENVIRONMENTS
- +VARIETY OF CHANGEABLE MESSAGE OPTION
- +CHANGEABLE MESSAGE OPTION
- +VARIETY BACKGROUND OPTIONS



PT-CA-GP2-68
Sub-Surfaced Digital Printed Background, (Custom Shape)

PT-CA-GP2-6x8
Topical Painted, 2-tone colors

PT-CM-GP2-9x6
Topical Painted, Digital Printed Insert

PT-CM-GP2-5x6
Topical Painted, Digital Printed Card stock Insert, Built in Grip-a-Strip Paper Holder

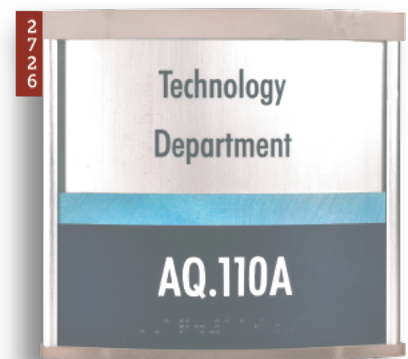

SP-CM-GP2-6x6
Satin Finish Frame, Custom Acrylic End Caps Clear Film Insert



SP-RR-GP2-GP5-6x9
Satin Finish Frame, Laminate Background



SP-CA-GP2-5x6
Satin Finished Frame, In-laid Laminates, Engraved Paint Filled Graphic

HOW OUR PHOTO-POLYMER SIGNS ARE MADE

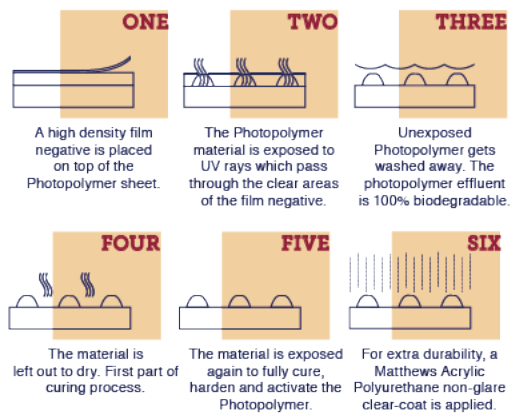

STANDARD SIGN TYPES

(Custom Sizes also Available)

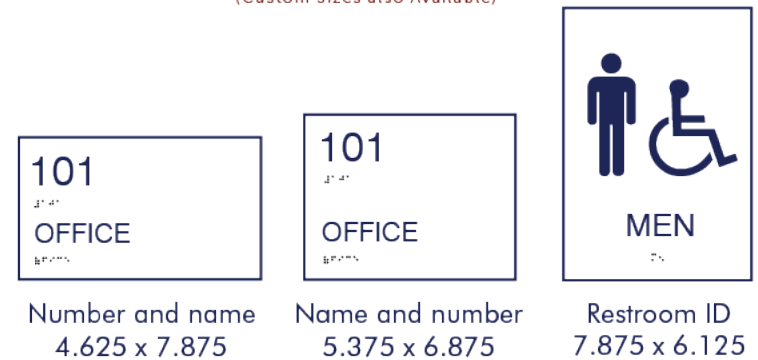

STANDARD SIGN TYPES

(Custom Sizes also Available)

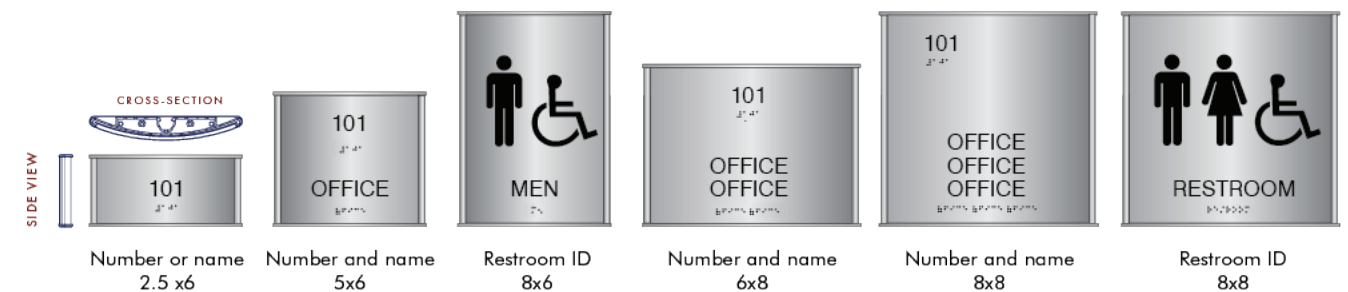

SUBSTRATES

+NOVACRYL PT

The greenest and most versatile line of signage photopolymers ever introduced. Clear PETG sign base allows for various finishing options. Available thickness: (1/16", 1/8", 1/4" 3/8").

+NOVACRYL LP

Clear photopolymer base is bonded to comprehensive offering of laminates made by leaders in the industry including Pionite, Wilsonart and Formica.

+NOVACRYL YA

Brushed aluminum face appearance.

+NOVACRYL EX

Exterior-grade photopolymer resin. Compatible with all exterior paints.

+NOVACRYL ECR

3 form ecoresin base is bonded to clear base.

+NOVACRYL PERM-AGLOW 150

Material absorbs ambient light during the day to provide photo-luminescent emergency guidance at night.

AlumiSet[®]

AlumiSet[®] is crafted from extruded, anodized aluminum. The frame can be painted to match any interior decor and the message design is easy to customize and update. Lens options and finishes include: polycarbonate, acrylic, laminate, clear and non-glare. Lenses have mechanical set screws to help prevent theft and vandalism. This system is ideally suited for federal institutions, healthcare facilities, educational and corporate environments.

The ADA insert can be extruded aluminum, laminate or acrylic. This insert is updatable and fixed with a set screw.

- +OPTIONAL GREEN COMPONENTS
- +COST EFFICIENT
- +FUNCTIONAL & DURABLE
- +TAMPER PROOF
- +STRONG ALUMINUM ALLOYS
- +CUSTOMIZABLE
- +UPDATABLE & INTERCHANGEABLE INSERTS



AL-RR-GP5-9x7
Satin Aluminum Extrusion,
Laminate Background



AL-CM-GP2-5.5x7
Satin Aluminum Extrusion,
Clear Lens with Digital Printed
CardStock Inserts



AL-CM-GP5-6.75x7
Satin Aluminum Extrusion,
Sub-Surfaced Paint, Clear Lens
with Digital Printed Insert



AL-CM-GP2-5.5x7
Satin Aluminum Extrusion, Clear
Lens with Digital Printed
CardStock Inserts

STANDARD SIGN TYPES

(Custom Sizes also Available)

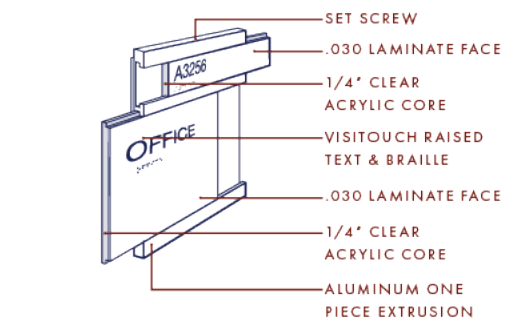
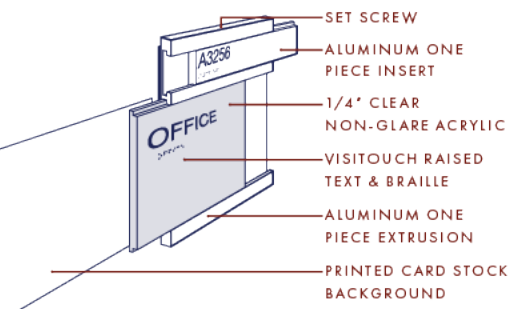
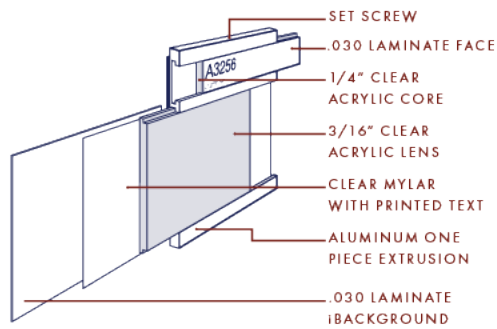
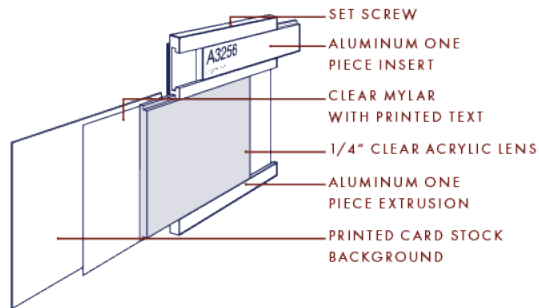
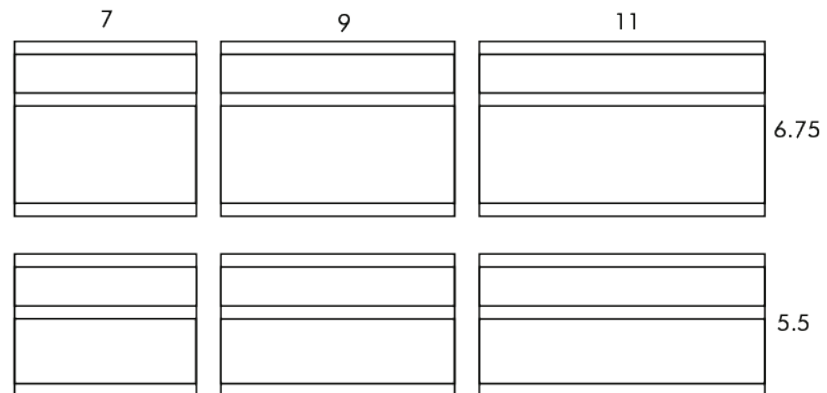

AlumiSet (FX)[®]

AlumiSet FX[®] is a part of the aluminum extrusion series, and the "FX" stands for "fixed." This sign system has a fixed heading and is crafted using a one-piece, extruded frame. Lenses are secured with mechanical set screws to help prevent theft. AlumiSet FX[®] is ADA compliant and ideally suited for corporate environments, federal institutions, healthcare and educational facilities.

The ADA FX portion is extruded within the frame. This gives the sign a clean stream line look.

- +OPTIONAL GREEN COMPONENTS
- +COST EFFICIENT
- +FUNCTIONAL & DURABLE
- +TAMPER PROOF
- +STRONG ALUMINUM ALLOYS
- +CUSTOMIZABLE
- +FIXED HEADING
- +UPDATABLE & INTERCHANGEABLE INSERTS



ALFX-CA-GP5-6.75x7
Aluminum Extrusion Clear
Acrylic Lens
Digital Printed Insert



ALFX-RR-GP5-9x7
Satin Aluminum
Extrusion, Laminate
Background

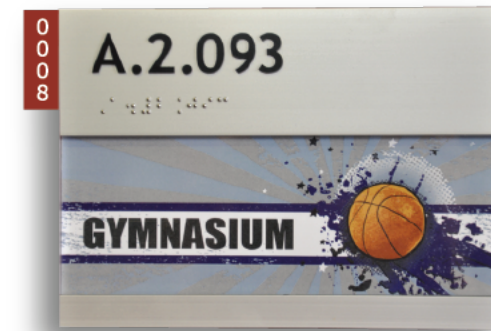

ALFX-CA-GP5-5.5x8
Aluminum Extrusion
Clear Acrylic Lens
Digital Printed Insert

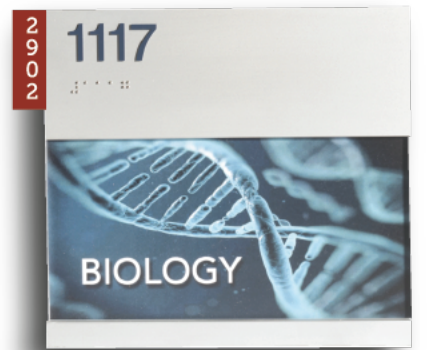

ALFX-CA-GP5-5.5x6
Aluminum Extrusion Clear
Acrylic Lens
Digital Printed Insert

LENS

- +polycarbonate (shatterproof)
- +laminate face with acrylic core
- +acrylic

LENS FINISHES

- +clear
- +non-glare

STANDARD SIZES

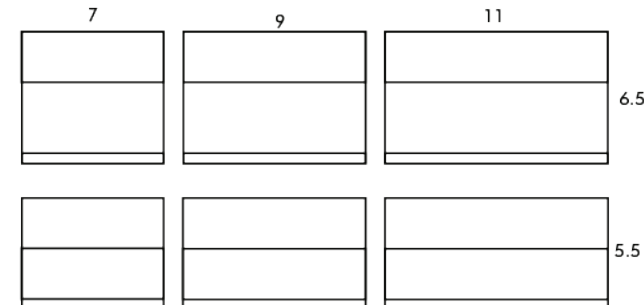

COMPONENTS & OPTIONS

(CUSTOM SIZES AVAILABLE)

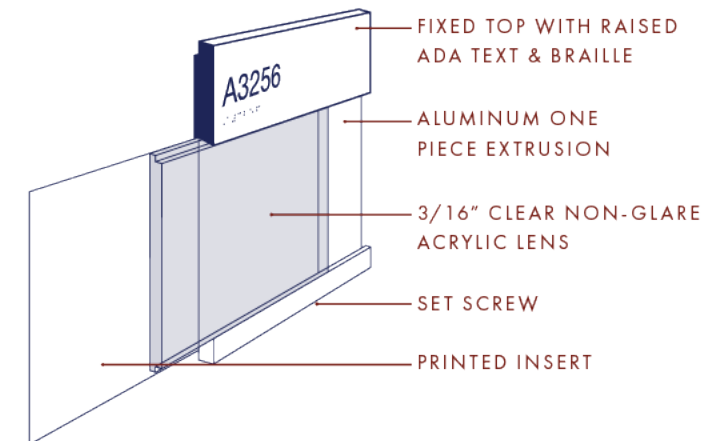

Other insert options same as AlumiSet, see on page 6

CS Series

CS Series extrusions are aluminum, bronze anodized or painted. They can be a frame or a partial frame. Sign Panels can be laminates, acrylic, metal, or photopolymer. This allows for total customization.

- +ADA COMPLIANT
- +ECO-FRIENDLY
- +SUITABLE FOR INTERIOR & EXTERIOR ENVIRONMENTS
- +PHOTO-LUMINESCENT MATERIAL AVAILABLE
- +CHANGEABLE MESSAGE OPTION

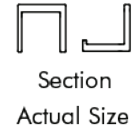

STANDARD SIGN TYPES

(Custom Sizes also Available)

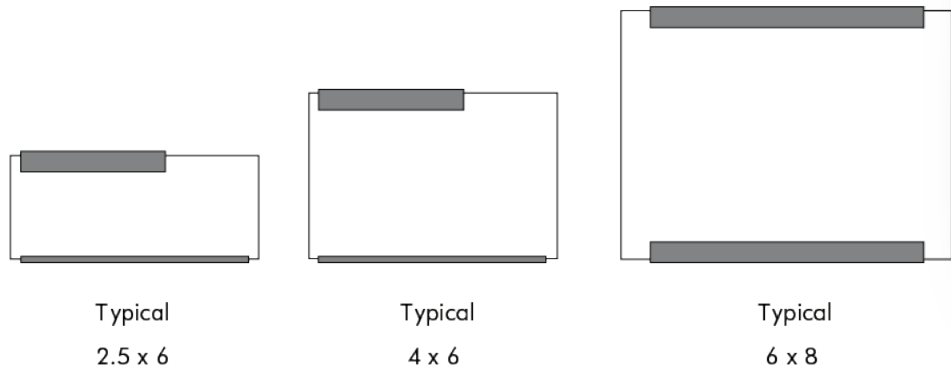

Installation

MOUNTING HEIGHT

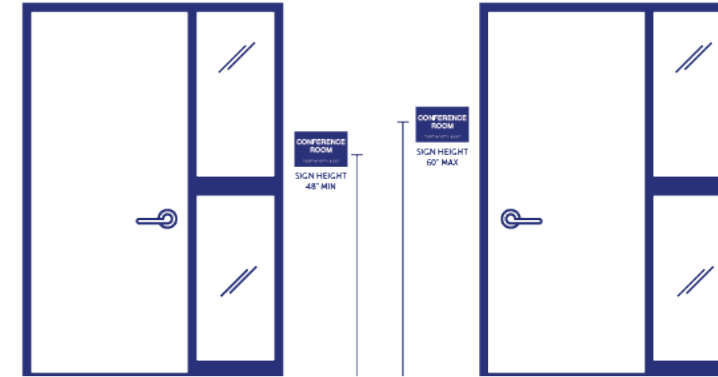

- + The baseline of the tactile copy can be mounted between 48" at the lowest point to 60" at the lowest point of the text. This allows signs of different sizes to be mounted on the same visual plane.
- + Elevator cars are excluded from this rule.

The ADA (American with Disabilities Act) helps remove barriers for people with disabilities. More than 2.5 million Americans suffer from a visual impairment—not just blindness. High contrast ADA compliant signs help ensure accessibility for the low vision and blind.

An ADA compliant sign is required for every permanent room or space in a public or commercial building. Always defer to your local building authority for regulations and code updates.

- + ada.gov
- + 2012 ADA SAD, Chapter 7
- + 2012 TAS ADA-ABA, Chapter 44

MOUNTING LOCATION



- + Single door: sign must be mounted next to door on latch side.



- + Inward swinging door: Sign may be mounted on door if three criteria are met:

1. The door closes automatically.
2. The sign is mounted on the push side of the door.
3. The door does not have a hold-open device.

Examples: kitchen doors, restroom doors, etc.



- + Outward swinging door: sign must be mounted to the wall outside of the arc of the door swing. Within an 18"x18" square of clear floor space.

18" away from the door and 18" away from the wall. See diagram.

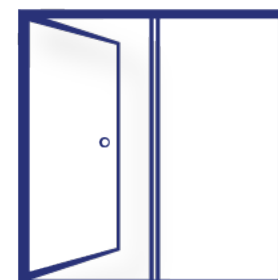
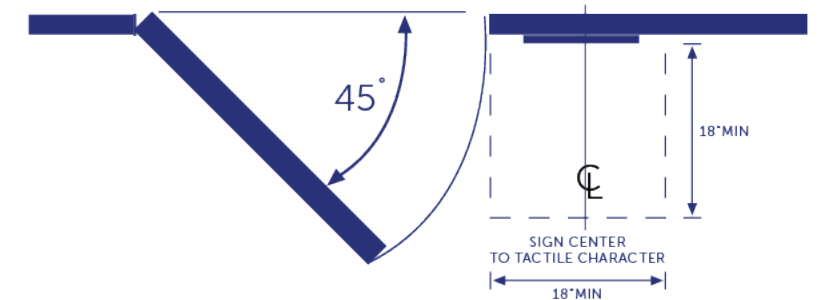

- + Double doors (one active leaf): Sign shall be placed on inactive leaf.

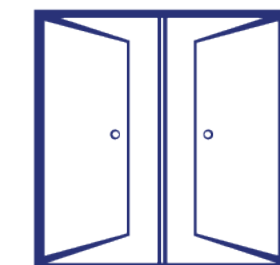

- + Double doors (two active leaves): Sign shall be placed to the right of the right handed door.

MOD Series

MOD (Modular) Series are coordinating modular components of laminate, acrylic or photopolymer. A few or many pieces may be used to complete one unit. Pieces can be changed as needed. Components usually consist of room number I.D., room name and changeable message.

- +ADA COMPLIANT
- +ECO-FRIENDLY
- +SUITABLE FOR INTERIOR & EXTERIOR ENVIRONMENTS
- +PHOTO-LUMINESCENT MATERIAL AVAILABLE
- +CHANGEABLE MESSAGE OPTION

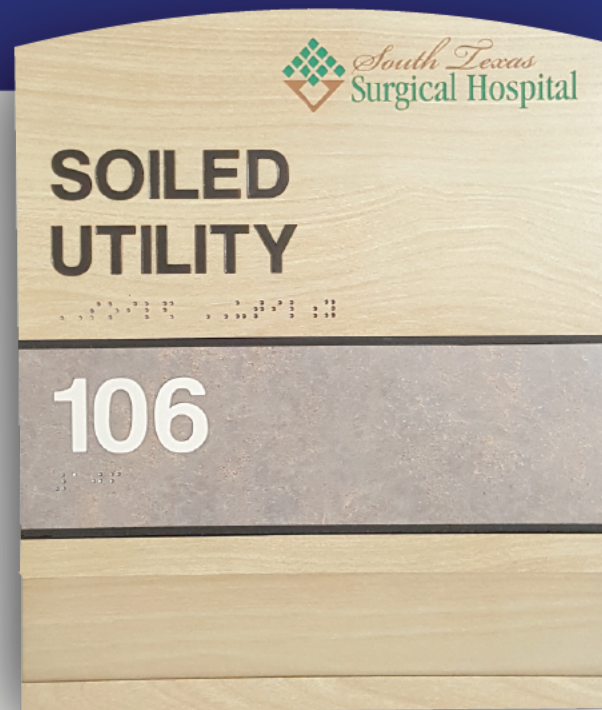

MOD-CM-GP2-9x6
Laminates with changeable message

STANDARD SIGN TYPES

(Custom Sizes also Available)

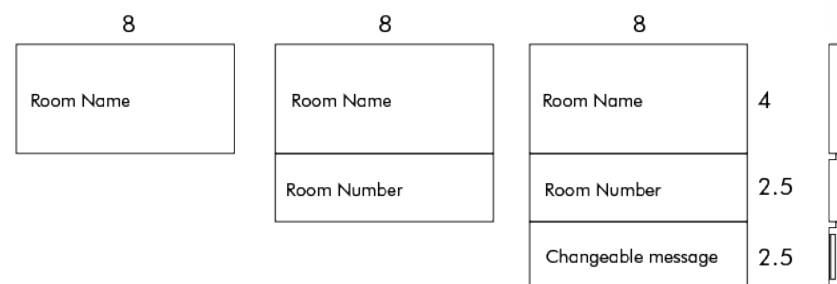

ADA Fonts

*The fonts below meet the 2010 Americans with Disabilities Act (ADA) standards for accessible design.

ARIAL REG.

AVANT GARDE MD

AVENIR 65 MED BT

FOLIO MD BT

FUTURA

GILL SANS MT COND.

KABEL MD BT

LUCIDA SANS

ABC | Futura, 5/8" High

All ADA text must be capitalized and 5/8" High. This makes reading the sign much easier.

MYRIAD PRO

SWIS 721 CN BT

SWIS 721 BT

TREBUCHET MS

TW Cen MT

ZAPIHUMNST DM BT

ZURICH CN BT

ZURICH BT